



AMERICANA
OUTDOORS

Elements for Life *Outside.*[™]
SHADE • SHELTER • SPORT • SITE



WWW.AMERICANA.COM

Who We Are

Americana is a family-owned company making high-quality recreational amenities for communities across the country. Our products are American-made and engineered to meet the demands of outdoor living. From shelters and seating to sports equipment, Americana offers architects, general contractors and other clients a full range of beautiful and fully customizable furnishings to create a complete outdoor environment that helps communities *work, play and live better.*

Pillars of Distinction



Engineered for Outdoor Living

We build products for every climate, every terrain and every purpose to meet the demands of outdoor living.



Shaping an Entire Outdoor Experience

From shelters and seating to sports equipment, Americana creates complete outdoor environments that enhance the quality of life for communities, promoting productivity, leisure, and well-being.



Providing Service that Comes Naturally

At Americana everyone is family and our clients are friends. When you care about the people around you and love what you do, great and knowledgeable service just comes naturally.



2025 Edition

Contents

02 Who We Are

03 Index

04 Featured Projects

10 Hip Roof Shelters

12 Monoslope Shelters

16 Split Roof Shelters

18 Gable Roof Shelters

26 Gazebo Shelters

30 Entryway Shelters

36 Walkway Shelters

38 Cantilever Shelters

40 Shade Shelters

44 Options & Accessories

50 Warranty

51 Site Furnishings



Featured Project:

The Commons of Washington

Washington, Indiana



From Above

The Commons in Washington, Indiana—a new beacon of community pride and connection! Situated in the heart of downtown, this vibrant public space symbolizes the spirit of togetherness and celebrates the shared heritage of Washington. Designed to foster gathering, celebration, and reflection, The Commons represents a cornerstone of downtown revitalization efforts.



Project Team

- Dealer(s): Tabor Owens Construction Group
- Engineer(s): Mark Peradotti, Alex Yarbrough
- Project Manager(s): Paul Casey & Dave Ashby



Products

(5) Custom Illini Shelters



Challenges

The development of The Commons in Washington, Indiana, was not without its challenges, but each hurdle underscored the resilience and determination of the community and its leaders. Transforming a central downtown space into a dynamic public hub required overcoming complex logistical, financial, and planning obstacles.

One significant challenge was balancing the historic charm of Washington's downtown with the modern functionality demanded by a space of this scope. Preserving the area's character while integrating contemporary features required a delicate design approach and thoughtful collaboration among architects, contractors, and community stakeholders.



Featured Project:

Bicentennial Park

Pantego, Texas



From Above

Bicentennial Park in Pantego, Texas, where community and recreation come together! Established in 1976 to celebrate our nation's bicentennial, this park has evolved to meet the needs of its residents. Following significant improvements over the years, including the addition of pedestrian bridges, gabion baskets for erosion control, and a splash pad, the park now features four Navajo shelters from Americana Outdoors Inc., installed in 2024. With its picturesque walking trails, engaging playground, and vibrant community events like "Eggcellent" Easter and Trunk-or-Treat, Bicentennial Park remains the heart of Pantego, offering high-quality recreation for all ages.



Project Team

- Dealer(s): Lea Park & Play, Inc
- Engineer(s): Mark Peradotti, Alex Yarbrough
- Project Manager(s): Erin Witzel



Products

- (1) 30x35' Extended Navajo Shelter
- (5) 30x30' Navajo Shelters



Challenges

The layout and limited space at Bicentennial Park necessitated meticulous planning to incorporate the six Navajo shelters while preserving the integrity of other recreational areas. Ensuring these new structures seamlessly blended with the park's natural environment and overall aesthetics was a top priority. Efficient management of construction logistics, including site access and materials delivery, was crucial to minimize inconvenience to park-goers. Overcoming these challenges, the addition of the Navajo shelters has significantly enhanced Bicentennial Park's offerings, providing the community with valuable gathering spaces to enjoy.



Featured Project:

Sandy Martin Legacy Gardens

Shoreview, Minnesota



From Above

Sandy Martin Legacy Gardens in Shoreview, Minnesota, where community and nature converge! Established to honor the lifelong service of Sandy Martin, Shoreview's longest-serving mayor from 1997-2022, this garden symbolizes dedication and community spirit. Completed in 2024 by Americana Outdoors Inc. with the help of LHB, Inc and Webber Recreational Design, the gardens highlight Sandy's impactful contributions, from public service to founding the Shoreview Community Foundation. With its beautiful landscapes and a legacy of inclusion, the Sandy Martin Legacy Gardens offer a tranquil retreat for all ages to enjoy and reflect on community values.



Project Team

- Dealer(s): Webber Recreational Design, Inc.
- Landscape Architect(s): LHB, Inc
- Engineer(s): Mark Peradotti, Alex Yarbrough
- Project Manager(s): Jay Henke



Products

- (1) Custom Artisan Pergola Trellis
- (1) Curved Artisan Pergola



Challenges

The layout and design of the Sandy Martin Legacy Gardens required careful planning to honor Sandy Martin's legacy while enhancing the park's natural beauty. Incorporating these new elements seamlessly into the garden's existing environment was a priority to ensure a cohesive aesthetic. Efficiently managing construction logistics, such as site access and material delivery, minimized disruptions to visitors. Overcoming these challenges, the gardens now offer serene spaces for reflection and community gatherings, celebrating Sandy's lasting impact on Shoreview and providing a cherished sanctuary for all to enjoy.



Hip Roof Shelters

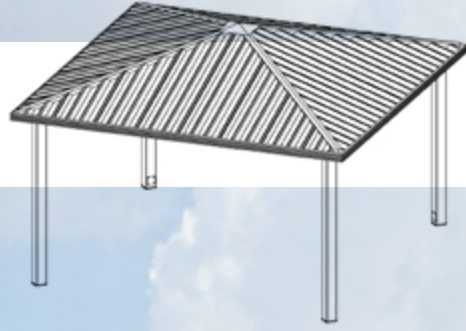



Navajo & Mojave Series

The Navajo and Mojave shelters offer sleek, dependable coverage in any outdoor setting. Designed with simplicity in mind by our expert engineers, these shelters seamlessly integrate into a variety of projects.

Sizes: 12x12' minimum, extended sizes up to 40x60'.

Roof Pitch: Standard 4/12.

Optional Roof Pitch: 6/12.

Structure: Four sided pre-fabricated, powder coated steel frame.

Frame: Tubular Steel.

Standard Roof System:

Navajo Model - 24" Aluminum "W" Panel with Extruded Aluminum Gutters.

Mojave Model - 36" Galvalume "R" panel with Aluminum Edge Trim, or Optional Gutter.

Optional Roof System:

18" Galvalume Standing Seam Panel with Extruded Aluminum Gutters, or Edge Trim with T&G Wood.

8" Aluminum Roll Formed Flat Panel with Extruded Aluminum Gutters.

Tongue & Groove Wood with Shingles.

Add-On Accessories: Cupola, double tier roof, dutch hip roof, steel railing.



Monoslope Shelters

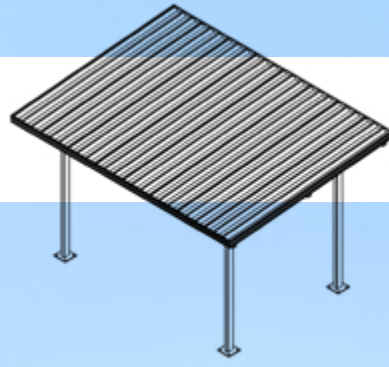



Monoslope Shelters

Presenting the Americana Monoslope Shelter: Enjoy modern, stylish defense in any outdoor setting with its unique monoslope architecture. Our expert engineers have devised an elegant, effortlessly adaptable shelter that harmoniously complements an array of projects.

Sizes: Ranging from 6-50' wide and 12-84' long.

Roof Pitch: Standard 1/12.

Optional Roof Pitch: 1/12 - 5/12.

Structure: Four sided pre-fabricated, powder coated steel frame.

Frame: Tubular Steel.

Standard Roof System:

24" Aluminum "W" Panel with Extruded Aluminum Gutters.

Optional Roof System:

36" Galvalume "R" panel with Aluminum Edge Trim, or Optional Gutter.

18" Galvalume Standing Seam Panel with Extruded Aluminum Gutters, or Edge Trim with T&G Wood.

8" Aluminum Roll Formed Flat Panel with Extruded Aluminum Gutters.

Tongue & Groove Wood with Shingles.

Add-On Accessories: Steel railing.



Monoslope Shelters

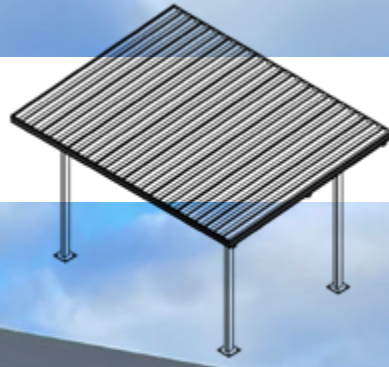



Algonquin Series

If you are looking for a shelter that provides a simple and sleek shade solution for your space, the Algonquin shelter could be the perfect choice for you. This shelter is designed to meet the needs of spaces that require basic shade solutions without compromising on style.

Sizes: Ranging from 10-12' wide and 10-24' long.

Structure: Pre-fabricated, powder coated Aluminum components.

Frame: Extruded Aluminum.

Standard Roof System:

24" Aluminum "W" Panel with Extruded Aluminum Gutters.

Optional Roof System:

8" Aluminum Roll Formed Flat Panel with Extruded Aluminum Gutters.

3" thick Insulated Aluminum Faced Panel with Edge Trim.

Add-On Accessories: Steel railing.



Split Roof Shelters

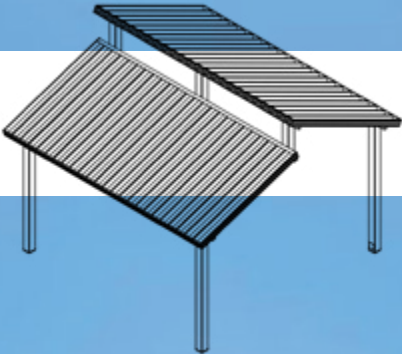



Split Roof Shelters

Presenting the Americana Split Roof Shelter: A striking and functional addition to any outdoor space. Its unique split roof design offers ample coverage while promoting natural airflow, making it perfect for parks, recreational areas, and community gatherings.

Sizes: Ranging from 6-50' wide and 12-84' long.

Roof Pitch: Standard 4/12.

Optional Roof Pitch: 1/12 - 12/12.

Structure: Four sided pre-fabricated, powder coated steel frame.

Frame: Tubular Steel.

Standard Roof System:

24" Aluminum "W" Panel with Extruded Aluminum Gutters.

Optional Roof System:

36" Galvalume "R" panel with Aluminum Edge Trim, or Optional Gutter.

18" Galvalume Standing Seam Panel with Extruded Aluminum Gutters, or Edge Trim with T&G Wood.

8" Aluminum Roll Formed Flat Panel with Extruded Aluminum Gutters.

Tongue & Groove Wood with Shingles.

Add-On Accessories: Steel railing.



Gable Roof Shelters

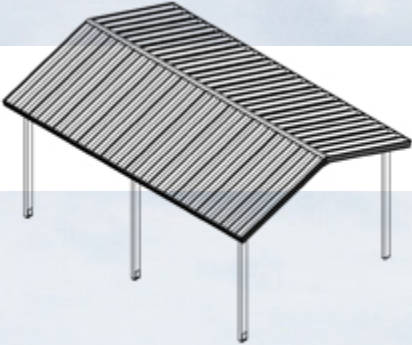



Illini Series

Gable roof shelters rank among the top choices for various applications, including city and community parks, educational institutions, rest stops, as well as residential and commercial endeavors. With sizes spanning from a modest 6' x 12' to a generous 50' x 84', these shelters offer versatile dimensions to suit your needs.

Sizes: Ranging from 6-60' wide and 12-84' long.

Roof Pitch: Standard 4/12.

Optional Roof Pitch: 1/12 - 12/12.

Structure: Four sided pre-fabricated, powder coated steel frame.

Frame: Tubular Steel.

Standard Roof System:

24" Aluminum "W" Panel with Extruded Aluminum Gutters.

Optional Roof System:

36" Galvalume "R" panel with Aluminum Edge Trim, or Optional Gutter.

18" Galvalume Standing Seam Panel with Extruded Aluminum Gutters, or Edge Trim with T&G Wood.

8" Aluminum Roll Formed Flat Panel with Extruded Aluminum Gutters.

Tongue & Groove Wood with Shingles.

Add-On Accessories: Steel railing.



Gable Roof Shelters

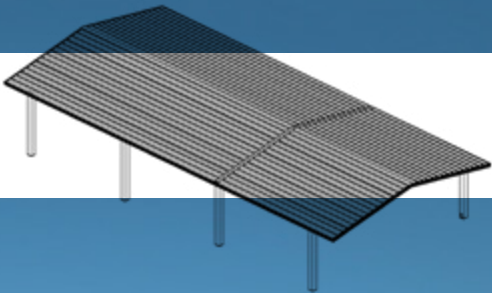



Meramec (DSA) Series

For spaces in need of straightforward shelter, the Meramec is the perfect solution. A classic gable roof design allows the Meramec to be installed in any outdoor environment to provide protection from the elements without detracting from the natural beauty of the space.

Sizes: Ranging from 20-41' wide and 20-54' long.

Roof Pitch: Standard 3/12.

Structure: Four sided pre-fabricated, powder coated steel frame.

Frame: Tubular Steel.

Standard Roof System:

24" Aluminum "W" Panel with Extruded Aluminum Gutters.

Optional Roof System:

3" thick Insulated Aluminum Faced Panel with Edge Trim.

Tongue & Groove Wood with Shingles.

Add-On Accessories: Steel railing



Gable Roof Shelters

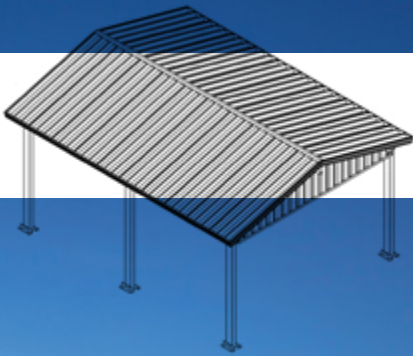



Colonial Series

The Colonial is a sophisticated take on a standard gable roof shelter, with an all-aluminum design, making it perfect for coastal regions. In addition, the gable fill makes this shelter particular attractive both as a standalone shelter and attached to the façade of building.

Sizes: Ranging from 12-22' wide and 20-40' long.

Roof Pitch: Standard 3/12.

Structure: Pre-fabricated, powder coated Aluminum components.

Frame: Tubular Aluminum.

Standard Roof System:

24" Aluminum "W" Panel with Extruded Aluminum Gutters.

Optional Roof System:

8" Aluminum Roll Formed Flat Panel with Extruded Aluminum Gutters.

3" thick Insulated Aluminum Faced Panel with Edge Trim.

Add-On Accessories: Aluminum Gable Fill kit is included.



Gable Roof Shelters

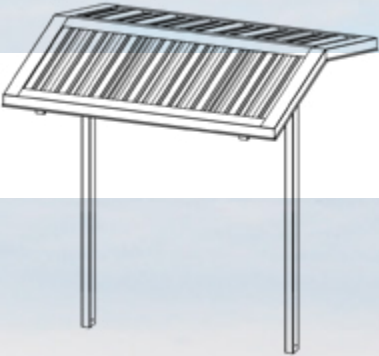



Cherokee Series

Americana Outdoors' Cherokee provides a mix of functionality and shelter, with its double posts acting as a mount for a display board, bench, or table, while also supporting an aluminum roof.

Sizes: Ranging from 8-12' wide and 8-12' long.

Roof Pitch: Standard 3/12.

Structure: Pre-fabricated, powder coated Steel Frame.

Frame: Tubular Steel, or Extruded Aluminum.

Standard Roof System:

24" Aluminum "W" Panel with Extruded Aluminum Gutters.

Optional Roof System:

36" Galvalume "R" panel with Aluminum Edge Trim, or Optional Gutter.

18" Galvalume Standing Seam Panel with Extruded Aluminum Gutters, or Edge Trim with T&G Wood.

8" Aluminum Roll Formed Flat Panel with Extruded Aluminum Gutters.

Add-On Accessories: Bulletin boards, bench, table & bench, double bench.



Gazebo Shelters

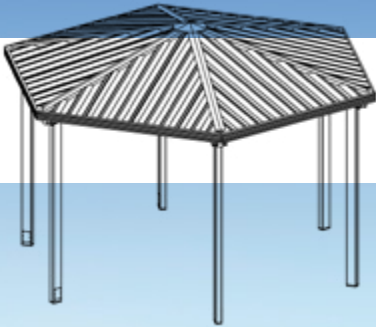



Apache Series

The Apache is Americana's most popular gazebo style shelter, due to the large range of size, style, and color options available. Featuring a six sided design, supported by six posts as standard, with a single post option available.

Sizes: 16-44' Diameter.

Roof Pitch: Standard 3/12.

Optional Roof Pitch: 4/12 - 8/12.

Structure: Hexagonal design, pre-fabricated, powder coated Steel frame.

Frame: Tubular Steel.

Standard Roof System:

24" Aluminum "W" Panel with Extruded Aluminum Gutters.

Optional Roof System:

36" Galvalume "R" panel with Aluminum Edge Trim, or Optional Gutter.

18" Galvalume Standing Seam Panel with Extruded Aluminum Gutters, or Edge Trim with T&G Wood.

8" Aluminum Roll Formed Flat Panel with Extruded Aluminum Gutters.

Tongue & Groove Wood with Shingles.

Add-On Accessories: Cupola, Double Tier Roof, Steel Railing, Benches.



Gazebo Shelters

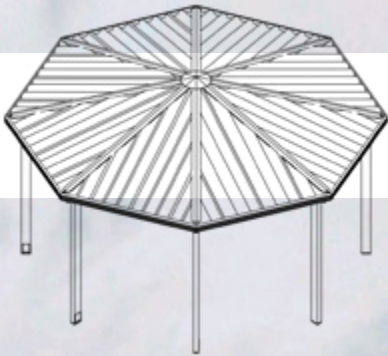



Aztec Series

The Aztec shelter delivers expansive coverage with a sleek design. Featuring Americana's patented "W" roofing panels, the eight-sided roof boasts enhanced rigidity and capability, requiring fewer panels than competitors' systems.

Sizes: 16-54' Diameter.

Roof Pitch: Standard 3/12.

Optional Roof Pitch: 4/12 - 8/12.

Structure: Octagonal design, pre-fabricated, powder coated Steel frame.

Frame: Tubular Steel.

Standard Roof System:

24" Aluminum "W" Panel with Extruded Aluminum Gutters.

Optional Roof System:

36" Galvalume "R" panel with Aluminum Edge Trim, or Optional Gutter.

18" Galvalume Standing Seam Panel with Extruded Aluminum Gutters, or Edge Trim with T&G Wood.

8" Aluminum Roll Formed Flat Panel with Extruded Aluminum Gutters.

Tongue & Groove Wood with Shingles.

Add-On Accessories: Cupola, Double & Triple Tier Roof, Steel Railing, Benches.



Entryway Shelters





Imperial Hanger Rod Canopy Series

Imperial Hanger Rod Canopies are designed to elegantly cover building entryways. This sophisticated canopy offers protection from the elements while enhancing curb appeal. Expertly crafted and durable, the Imperial is a stylish and functional addition to any entrance, ensuring a welcoming experience for visitors and occupants alike.

Sizes: Ranging from 2' 6"-10' projection and 4-100'+ long. Lengths upwards of 1000'+ with splices.

Structure: Pre-fabricated, powder coated Aluminum components.

Gutters / Fascia: Extruded Aluminum, 6", 8", or 12" fascia with 4" gutter.

Standard Roof System:

8" Aluminum Roll Formed Flat Panel with Extruded Aluminum Gutters.

Optional Roof System:

6" Aluminum Extruded Flat Panel, with Extruded Aluminum Gutters.

10" Aluminum Roll Formed "V" panel.

24" Aluminum "W" Panel with Extruded Aluminum Gutters.

1.5" square Aluminum Extruded Lattice.

Supports: Overhead "Hanger Rod" braces.

Add-On Accessories: Crown Molding.



Entryway Shelters





Imperial Post Supported Canopy Series

Imperial Post Supported Canopies are designed to elegantly cover building entryways. This sophisticated canopy offers protection from the elements while enhancing curb appeal. Expertly crafted and durable, the Imperial is a stylish and functional addition to any entrance, ensuring a welcoming experience for visitors and occupants alike.

Sizes: Ranging from 4-10' projection and 4-100+' long. Lengths upwards of 1000'+ with splices.

Structure: Pre-fabricated, powder coated Aluminum components.

Gutters / Fascia: Extruded Aluminum, 6", 8", or 12" fascia with 4" gutter.

Standard Roof System:

8" Aluminum Roll Formed Flat Panel with Extruded Aluminum Gutters.

Optional Roof System:

6" Aluminum Extruded Flat Panel, with Extruded Aluminum Gutters.

10" Aluminum Roll Formed "V" panel.

24" Aluminum "W" Panel with Extruded Aluminum Gutters.

1.5" square Aluminum Extruded Lattice.

Supports: Extruded Aluminum Posts.

Add-On Accessories: Crown Molding.



Entryway Shelters

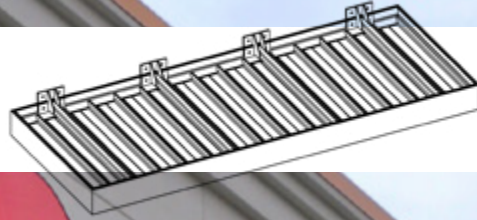



Imperial Cantilever Canopy Series

Imperial Cantilever Canopies are designed to elegantly cover building entryways without any visible supports, providing a "floating" stylization. This sophisticated canopy offers protection from the elements while enhancing curb appeal. Expertly crafted and durable, the Imperial is a stylish and functional addition to any entrance, ensuring a welcoming experience for visitors and occupants alike.

Sizes: Ranging from 2' 6"- 5' projection and 4-100'+ long. Lengths upwards of 1000'+ with splices.

Structure: Pre-fabricated, powder coated Aluminum components.

Gutters / Fascia: Extruded Aluminum, 6", 8", or 12" fascia with 4" gutter.

Standard Roof System:

8" Aluminum Roll Formed Flat Panel with Extruded Aluminum Gutters.

Optional Roof System:

6" Aluminum Extruded Flat Panel, with Extruded Aluminum Gutters.

10" Aluminum Roll Formed "V" panel.

24" Aluminum "W" Panel with Extruded Aluminum Gutters.

1.5" square Aluminum Extruded Lattice.

Supports: "Hidden" Cantilever Mounts.

Add-On Accessories: Crown Molding.



Walkway Shelters

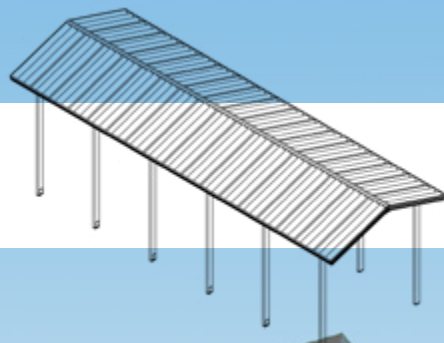



Walkway Shelters

Whether you need to protect your guests from the sun, rain, or snow, our Walkway Shelters are the perfect solution. With a range of sizes, styles, and colors to choose from, we're confident that we have the perfect shelter to suit your needs.

Sizes: Ranging from 6-50' wide and 10-80' long.

Roof Pitch: Varies depending on structure needs.

Structure: Pre-fabricated, powder coated Steel components.

Frame: Tubular Steel.

Standard Roof System:

24" Aluminum "W" Panel with Extruded Aluminum Gutters.

Optional Roof System:

36" Galvalume "R" panel with Aluminum Edge Trim, or Optional Gutter.

8" Aluminum Roll Formed Flat Panel with Extruded Aluminum Gutters.

6" Aluminum Extruded Flat Panel, with Extruded Aluminum Gutters.

Add-On Accessories: Steel railing.



Cantilever Shelters

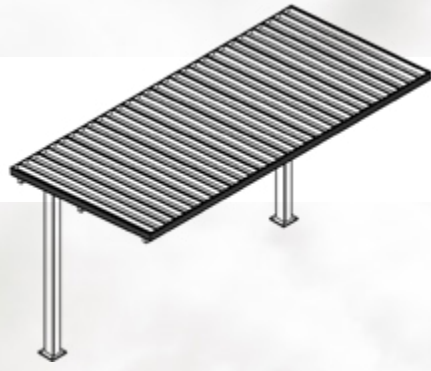



Shawnee Series

Shawnee Shelters are designed with dugouts specifically in mind, giving you a product that will keep your team protected no matter the weather on game day. Our project managers work with customers to create a perfect sized Shawnee for any sport site needs.

Sizes: Varies depending on application and structure needs.

Structure: Pre-fabricated, powder coated steel frame.

Frame: Tubular Steel.

Standard Roof System:

24" Aluminum "W" Panel with Extruded Aluminum Gutters.

Optional Roof System:

36" Galvalume "R" panel with Aluminum Edge Trim, or Optional Gutter.

18" Galvalume Standing Seam Panel with Extruded Aluminum Gutters, or Edge Trim with T&G Wood.

8" Aluminum Roll Formed Flat Panel with Extruded Aluminum Gutters.

Tongue & Groove Wood with Shingles.

Add-On Accessories: Steel railing, Extruded Aluminum Benches/Bleachers.



Shade Shelters

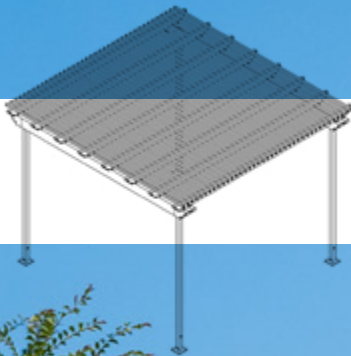



Pergola Series

The Americana Outdoors® line of pergola products are the perfect addition to any outdoor environment. The timeless, elegant design complements any exterior space, adding the ideal amount of shade, while not obstructing your view of nature. Our pergolas are available in multiple sizes and colors to best serve your space.

Sizes: Custom designed to fit your application.

Structure: Pre-fabricated, powder coated Aluminum components.

Frame: Tubular Steel or Extruded Aluminum.

Header Options:

- Curved, or Straight Steel
- Extruded Aluminum
- 3x8" Wood Grain Embossed Aluminum

Roof Options:

- Wood Grain Embossed Aluminum Lattice
- Round Extruded Aluminum Tubes
- Laser Cut Aluminum Panels (Multiple Designs Available).

Add-On Accessories: Fabric Drapes, Roll-Up Curtains.



Shade Shelters

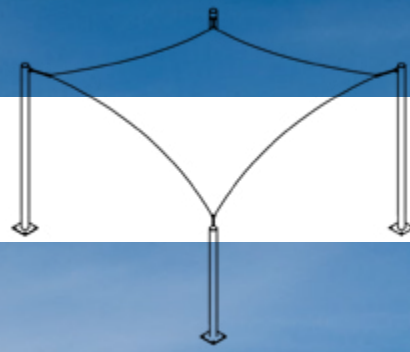



Shade Sail Series

The Americana Outdoors® line of pergola products are the perfect addition to any outdoor environment. The timeless, elegant design complements any exterior space, adding the ideal amount of shade, while not obstructing your view of nature. Our pergolas are available in multiple sizes and colors to best serve your space.

Sizes: Custom designed to fit your application.

Structure: Pre-fabricated, powder coated Steel components.

Frame: Tubular Steel.

Fabric: Maintenance-free high strength 100% HDPE round yarn.

Fabric Top: Designed to withstand high winds.

Optional Roof Options: 10 Vibrant colors available.





Railing Options

Railings are a great way to add a unique touch to your structure and can be incorporated into most designs. There are several standard designs available, inspired by common architectural styles, and customized designs are available to suit your project's needs. Top Railings are 12" tall, Bottom Railings are 42" tall, made from 3/16" thick steel.

Line



Square

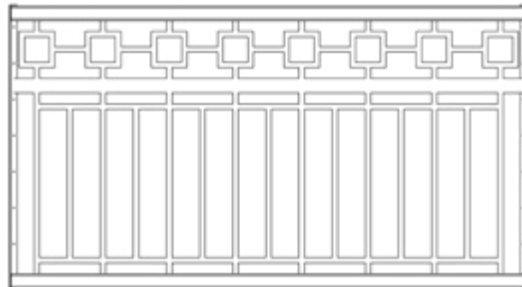
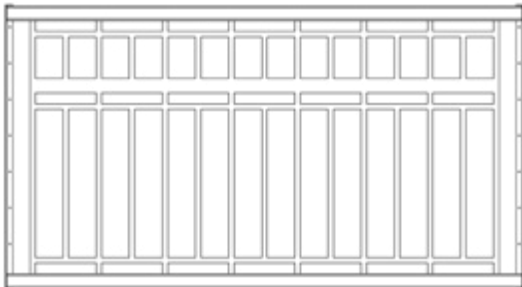
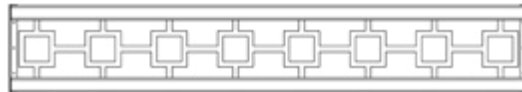

Rectangle

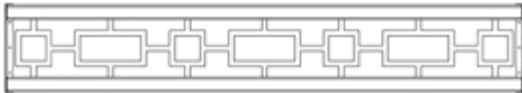

Circle

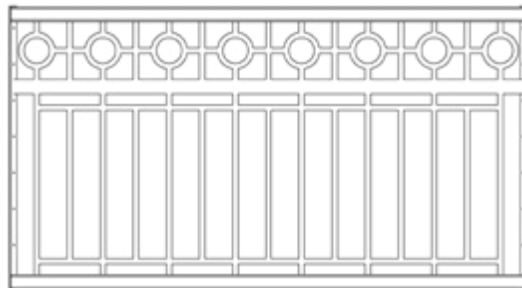
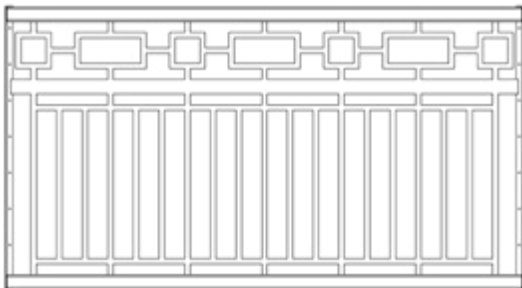
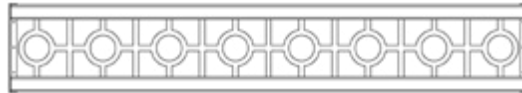



Cupola, Clerestory, & Gable Options

Our Cupolas, Clerestories, & Gables are designed to add natural light, ventilation, and a touch of elegance to your shelter. The Cupolas come standard with an Open design, or an optional Louvered panel. We also offer a fully customizable, laser cut panel option for the Cupolas, Clerestories, & Gables. Which is ideal for displaying logos, affiliations, or project sponsors.

Cupola Options

24 x 24"

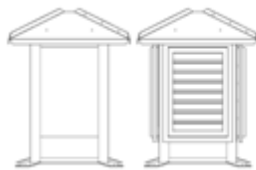

48 x 48"



72 x 144"

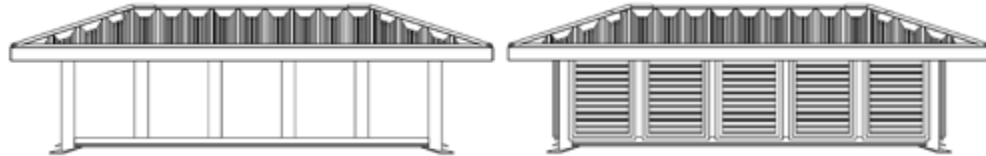

Hexagon (6 Sided) Cupola



Octagon (8 Sided) Cupola



Clerestory & Gable Examples

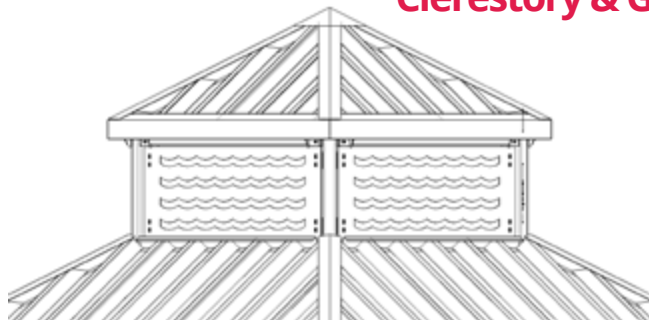



Frame & Post Style

Americana Shelters feature American-made steel tubular frames, pre-drilled for easy bolt-together assembly, and detailed instructions that reduce installation costs. Fasteners are zinc-plated, galvanized, or stainless steel to prevent rust and stains.

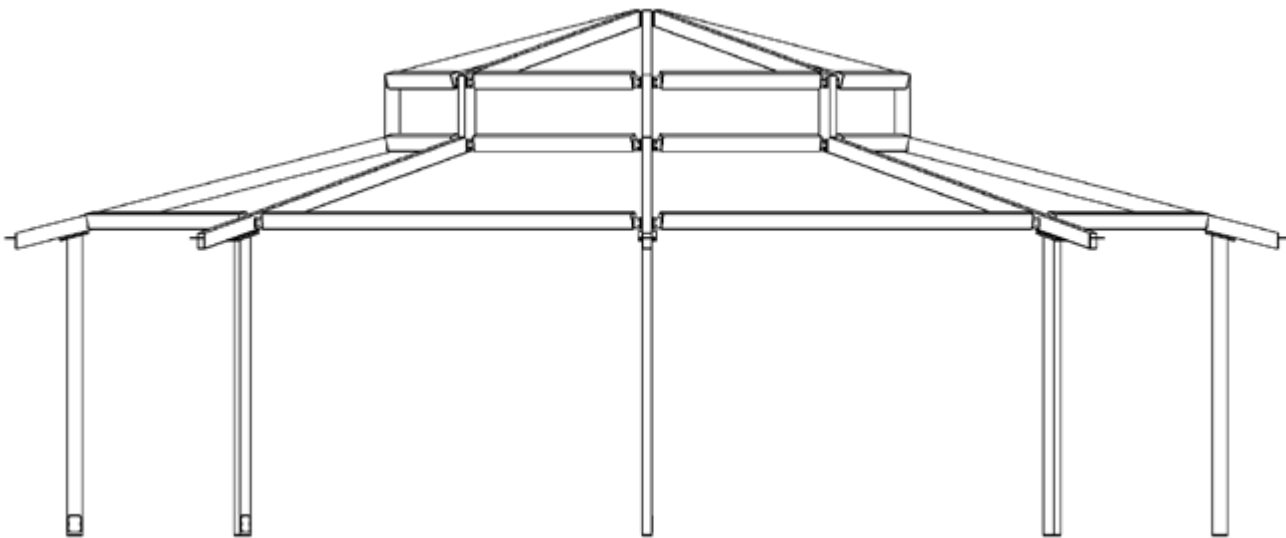

Standard Post Base Plate Connections

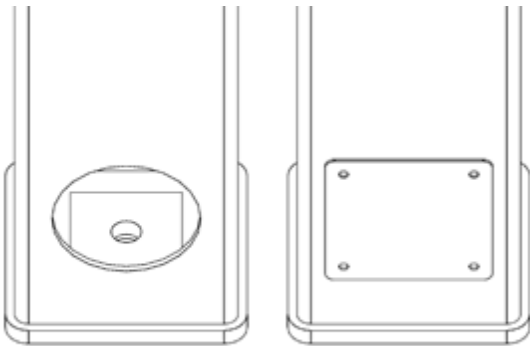

Internal Anchor Bolt with Cover Plate

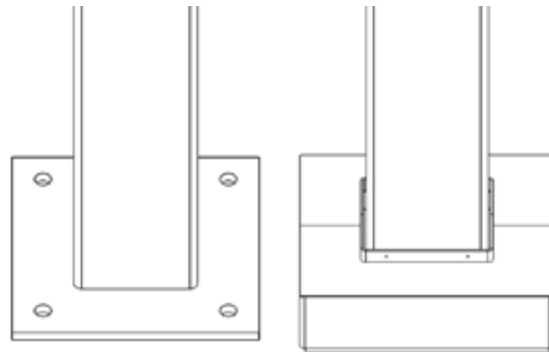

External Anchor Bolts with Optional Cover



Roof Panel Colors & Options

We take great pride in producing a majority of our roof panel options in-house, which gives us complete control over the quality and production schedule. By doing so, we are able to provide our customers with top-notch products while also passing on cost savings

24" Aluminum Structural "W" Panel

Features:

Structural roof panel designed to limit the amount rafters & purlins per structure.

Best overall value when comparing cost & strength.

Gutters are included for water erosion management.



Coverage Width - 24"
 Minimum Slope - 1/2:12
 Thickness - .038" & .024" (560 Anodized Only)
 Finish - Stucco Embossed
 Coatings - DuraCoat XT40 Ceranamel
 Rib Spacing - 8" on center
 Rib Height - 2-1/2"

Compatible with all model shelters except for Pergola



36" Galvalume® 26 Gauge "R" Panel

Features:

Flush fit for a cleaner, sleeker appearance.

Designed to deter bird roosting.

Edge trim is included for a simple & flawless finish.



Coverage Width - 36"
 Minimum Slope - 1/2:12
 Gauge - 26
 Finish - Smooth
 Coatings - Siliconized Polyester (Series 200) | Polyvinylidene Fluoride (Series 300)
 Rib Spacing - 12" on center
 Rib Height - 1-1/4"

Compatible with all model shelters except for Meramec, Colonial & Pergola

Signature 200 Series | High Gloss

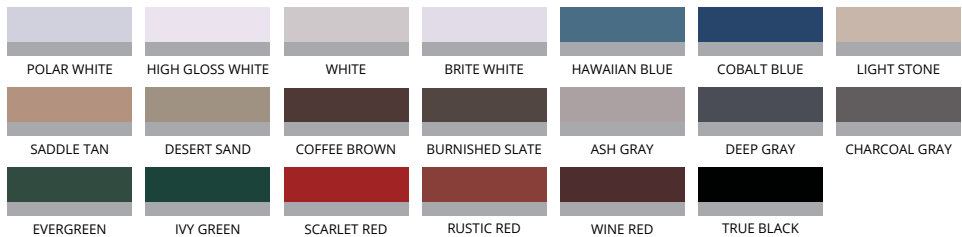

Signature 300 Series | Low Gloss



Each color has a wash coat on the underside, paired with an inked date stamp for manufacturer warranty verification.



Roof Panel Colors & Options

Features:

Flush fit for a cleaner, sleeker appearance.

Designed to deter bird roosting.

Gutters are included for water erosion management. Edge trim is standard with tongue and groove wood substructures applications.

18" Galvalume® 24 Gauge Standing Seam Panel

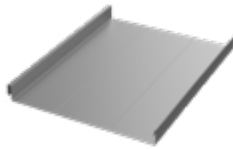

Coverage Width - 18"
 Minimum Slope - 1/2:12
 Gauge - 24
 Finish - Smooth
 Coatings - Siliconized Polyester
 Rib Spacing - N/A
 Rib Height - 1-3/4"

Compatible with all model shelters except for Meramec, Colonial, & Pergola

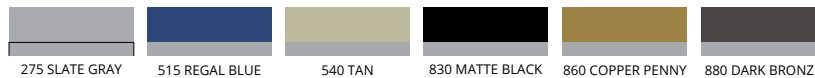

Each color has a wash coat on the underside, paired with an inked date stamp for manufacturer warranty verification.

Tongue and Groove Wood

Utilized as sub roofing for shelters using the 18" standing seam panels or shingles.

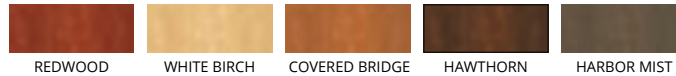

Premium Southern Yellow Pine with an optional rich pigmented stain and/or sealer, comes uncoated as standard.

Features:

Flush fit for a cleaner, sleeker appearance.

Designed to deter bird roosting.

Gutters are included for water erosion management.

8" Aluminum Structural Flat Panel

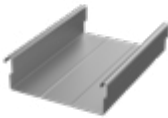

Coverage Width - 8"
 Minimum Slope - 1/2:12
 Thickness - .024", .032", & .040"
 Finish - Smooth Matte Finish
 Coatings - DuraCoat XT40 Ceranamel
 Rib Spacing - N/A
 Rib Height - 2-5/8"

Compatible with all model shelters except for Meramec & Pergola



Features:

Flush fit for a cleaner, sleeker appearance.

Designed to deter bird roosting.

Gutters are included for water erosion management.

6" Aluminum Extruded Flat Panel



Coverage Width - 6"
 Minimum Slope - 1/2:12
 Thickness - .065"
 Finish - Smooth Gloss Finish
 Coatings - Super Durable Polyester
 Rib Spacing - N/A
 Rib Height - 2-7/8"

Compatible only with Walkways & Entry Covers



Powder coat finish available in all frame colors. Full RAL color palette available at additional cost.

Features:

Insulated panels for noise and temperature control.

Flush fit for a cleaner, sleeker appearance.

3" Thick Insulated Aluminum Panel White stucco finish with foam core

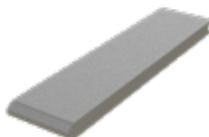

Compatible with all model shelters except for Cherokee, Pergola, Walkways & Entry Covers



Frame & Fabric Color Options

Our Americana Industrial Coatings division enables us to powdercoat all of our products in-house, setting us apart from our competitors. This grants us complete authority over pricing, quality, and production times, allowing us to transfer these benefits to our customers.









Super Durable Frame Color Options

					
205 ORANGE RAL 2004	215 YELLOW	220 RAVEN (TEXTURED)	235 NAVY BLUE RAL 5003	240 ROYAL BLUE RAL 5005	242 SKY BLUE RAL 5015
					
245 CAST BRONZE RAL 8019	265 HUNTER GREEN RAL 6005	270 QUARTZ GRAY RAL 7039	275 SLATE GRAY	285 RED RAL 3001	290 SILVER
					
815 ASH GRAY	820 CHARCOAL GRAY	840 COLONIAL RED	865 LIGHT GREEN		

Super Durable & Anti Graffiti Frame Color Options

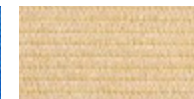
					
510 BLACK	515 REGAL BLUE	520 BRONZE	525 BROWN	530 CLAY	535 IVORY
					
540 TAN	545 TERRA COTTA	550 WHITE	555 DARK GREEN		

Fabric Shelter Color Options

					
YELLOW	ORANGE	CRIMSON	GRAPE	OCEAN BLUE	SAND
					
FOREST GREEN	LIME GREEN	GRAPHITE	JET BLACK		

Sales & Installation Support

Design and engineering support and documentation to satisfy local requirements: Heavy Snow, Seismic, High Winds, Hail, Custom Designs & Sizes.

Average standard lead times are 6-8 weeks from receipt of approved order. Lead times may vary on design criteria.

Installation and sales support available M-F (8am-5pm) central standard time.

Since Americana is a custom manufacturer, non-standard items are routinely fabricated with no delays. Minimal extra charges may be incurred for engineering.

Warranty Terms

Lifetime Limited Warranty

Lifetime Limited Warranty on aluminum against material failure and corrosion.

25 Year Limited Warranty

25 Year Limited Warranty on steel against material failure and defects.

10 Year Limited Warranty

10 Year Limited Warranty on Sunbrella, Sheerweave, & Solamesh Fabrics

10 Year Limited Warranty on all powder coat finishes (200, 500 and 800 series).

With the use of Americana's 500 Series Anti-graffiti powder coat finish is guaranteed to allow removal of graffiti with virtually no change to the finish.

5 Year Limited Warranty

5 Year Limited Warranty on Soltis 86 fabrics.

1 Year Warranty

1 Year warranty against defects in materials and workmanship.

Period of Coverage:

The warranty period begins on the date of the original shipment.

What Americana Will Do To Correct Problems:

If defects or damage of the kind mentioned above should occur within the warranty period, Americana will replace the defective parts only; FOB its plant at Salem, Illinois, upon receiving the written and documented claim of the purchaser.

Warranty Exclusions:

Because of the normal aging and weathering of materials, it may not be possible to perfectly match the colors of original parts and replacement parts. Americana will not provide or pay for the installation of such replacement parts. Americana shall not be responsible for weather-related failures, damages due to faulty installation, misuse or abuse of the product, or for consequential damages, including personal injuries or property damages. There are no warranties, express, or implied, which extend beyond the description on the face hereof.

How To File A Warranty Claim:

If you believe that you have a claim under this warranty, submit a copy of your original receipt or other reasonable evidence of the date of purchase, the identity of the product, and photos and a description of the allegedly defective product to the address below. Please also include your name, address, and phone number so that a customer service representative can respond to your submission. The ultimate determination of the existence and extent of any claimed defect under this warranty shall be made by Americana in its sole discretion.

Submit Claims To:

Americana Outdoors, Inc, Warranty Claim
P.O. Box 1290
Salem, IL 62881



Looking for Premium Quality Site Furnishings to complement your new shelter? Do you need field or sports court equipment to help the games happen? PW Athletic & LA Steelcraft, subsidiaries of Americana Outdoors have you covered!

Our selections of various site furnishings and sports equipment are a perfect match to the craftsmanship and quality of the Americana Outdoors shelters. Like our shelter products, our site furnishings and sports equipment are 100% made in the U.S.A. and have the best warranties in the industry.

For more information give us a call on 1-888-442-2925
or visit our website at www.PWathletic.com or www.LASteelcraft.com



PO Box 1290, Salem IL 62881
1-800-851-0865, Fax: 1-618-548-2890
Sales@Americana.com
www.Americana.com



2025 SHELTER CATALOG